

INSTALLATION MANUAL

70107

Level of Difficulty

Moderate

Installed Attachment Tabs

Height	23"
Width	28"

Parts List

Item	Qty	Description
1	1	Tow bar base plate
2	2	Spacer, two-hole
3	2	Tube spacer
4	2	Spacer plate
5	2	Tow bar mounting tab
6	2	Safety cable, 7,500 lbs.
7	6	Carriage bolt, 1/2"-13, 3-1/4", grade 8
8	6	Flange nut, 1/2"-13, grade 8
9	1	Cable tie, 15"
10	2	Quick link, 1/2"
11	2	Socket plug

Tools Required

Torque wrench	Socket, 3/4"
Socket, 7mm	Socket, 10mm
Socket, 15mm	Socket, 18mm
Wrench, 15mm	Wrench, 18mm
Wrench, 3/4"	Reciprocating saw
Flat screwdriver	Utility knife
Fishwire, 3/8" (includes four)	T15 Torx bit

⚠ WARNING

Never exceed the vehicle manufacturer's recommended gross vehicle weight rating (GVWR).

Product Photo



Not pictured: Safety cables, quick links and socket plugs

⚠ CAUTION

Take care when cutting any plastic or metal as injury may occur if done improperly.

NOTICE

Before you begin installation, read all instructions thoroughly.

Proper tools will improve the quality of installation and reduce the time required.

This installation requires the factory bumper, front fascia panels, tow hooks and air baffle to be temporarily removed and reinstalled. Some trimming is also required.

To help prevent damage to the product or vehicle, refer to the specified torque specifications when securing hardware during the installation process.

If equipped, we recommend removing the base plate attachment tabs when not in use.

Torque Specifications

Metric	Bolt Size	CL8.8	CL10.9	SAE	Bolt Size	Grade 5	Grade 8
	M6 bolt	6.6 ft-lbs.	9.4 ft-lbs.		1/4" bolt	86 in-lbs.	122 in-lbs.
M8 bolt	16.0 ft-lbs.	22.9 ft-lbs.	5/16" bolt	178 in-lbs.	251 in-lbs.		
M10 bolt	31.6 ft-lbs.	45.2 ft-lbs.	3/8" bolt	26 ft-lbs.	37 ft-lbs.		
M12 bolt	55.1 ft-lbs.	78.9 ft-lbs.	7/16" bolt	42 ft-lbs.	59 ft-lbs.		
M14 bolt	88.1 ft-lbs.	126.1 ft-lbs.	1/2" bolt	75 ft-lbs.	110 ft-lbs.		
M16 bolt	136.7 ft-lbs.	195.6 ft-lbs.	5/8" bolt	128 ft-lbs.	180 ft-lbs.		
M18 bolt	195.4 ft-lbs.	270.3 ft-lbs.	3/4" bolt	227 ft-lbs.	320 ft-lbs.		

Use above torque setting unless otherwise noted

ASSEMBLY

Parts List

Item	Qty	Description
1	1	Tow bar base plate
2	2	Spacer, two-hole
3	2	Tube spacer
4	2	Spacer plate
5	2	Tow bar mounting tab
6	2	Safety cable, 7,500 lbs.
7	6	Carriage bolt, 1/2"-13, 3-1/4", grade 8
8	6	Flange nut, 1/2"-13, grade 8
9	1	Cable tie, 15"
10	2	Quick link, 1/2"
11	2	Socket plug

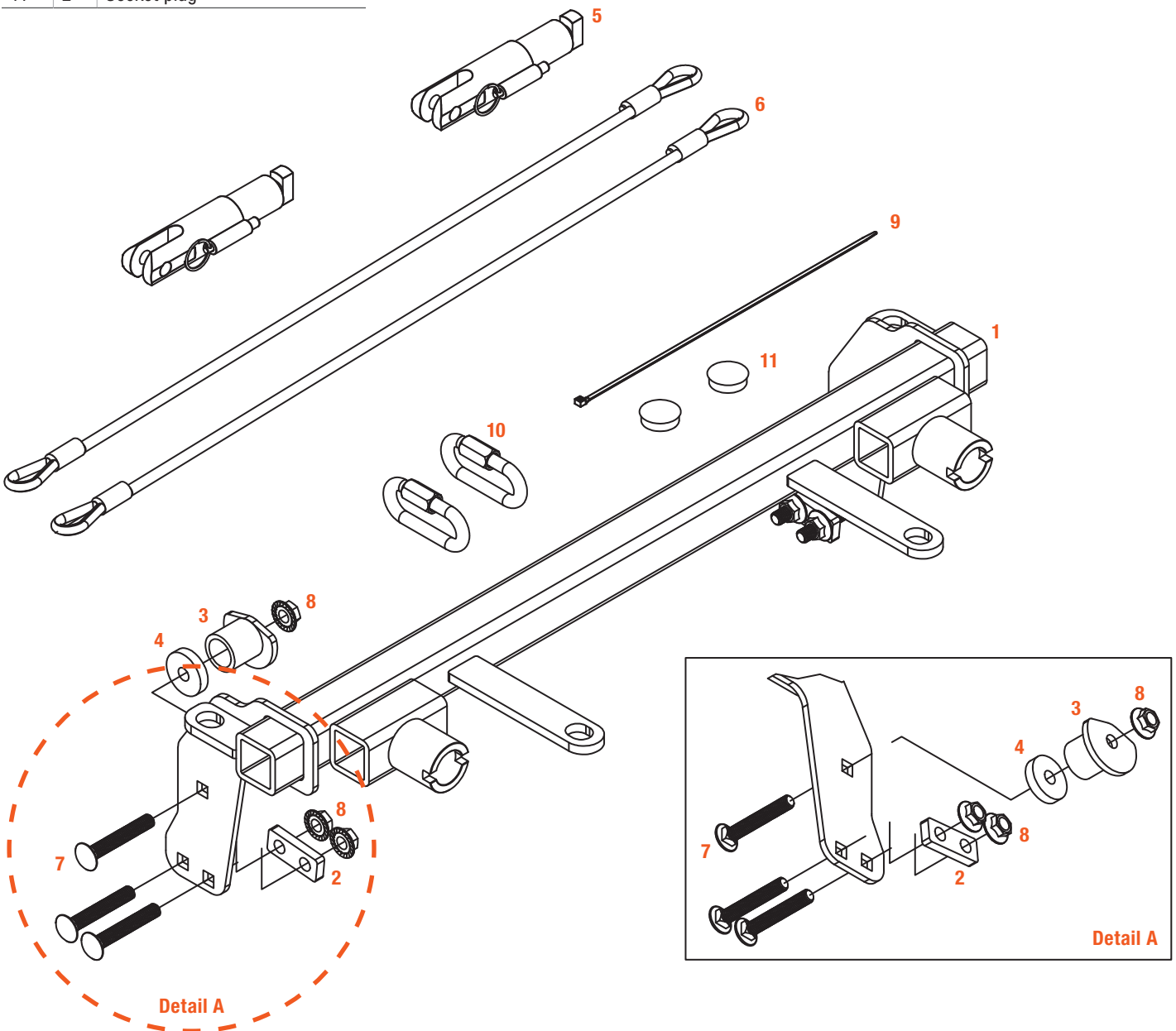

FASCIA & BUMPER REMOVAL

COLORADO / CANYON

Step 1

For Colorado ZR2 models, skip to Step 9.

Open the hood and use a T15 Torx bit to remove the six screws holding the top fascia panel in place.

Note: The GMC Canyon will have nine push pins instead – three on each side and three in the center. Pull these out and remove the radiator cover.

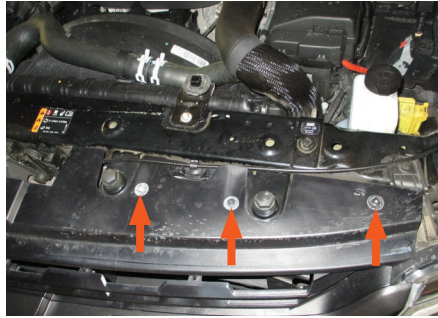

Step 2

Use a T15 Torx bit to remove the four screws along the inside edge of the fender flare.

Repeat on the other side of the vehicle.



Step 3

Pull the fender flare out and use a T15 Torx bit to remove the wheel well screw behind the flare.



COLORADO / CANYON (CONTINUED)

Step 4

Pull back the wheel well liner and use a 7mm socket to remove the three screws where the fascia and fender meet.

Repeat on the other side of the vehicle.

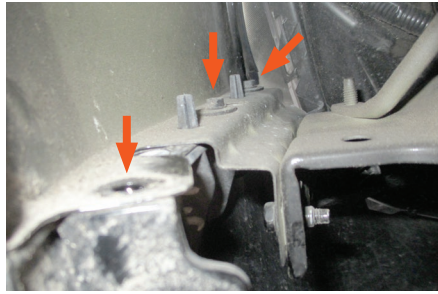

Step 5

Use a T15 Torx bit to remove the ten screws from the underside of the front fascia panel – five on each side.



Step 6

Use a 10mm socket to remove two bolts securing the bumper cover. Carefully remove the bumper cover, disconnecting the fog light wiring harnesses (if present) before complete removal.

Set the bumper aside to be installed later.



COLORADO / CANYON (CONTINUED)

Step 7

Use a 15mm socket to remove the four bolts holding the factory bumper in place.

Remove the bumper and set it aside.

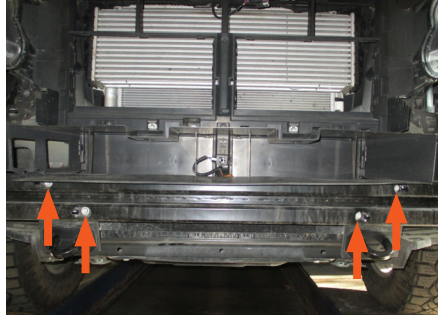

Step 8

Remove the three push pins on top of the air baffle. Then, use a flathead screwdriver to unsnap the outside edges of the baffle.

Once removed, set the baffle aside.

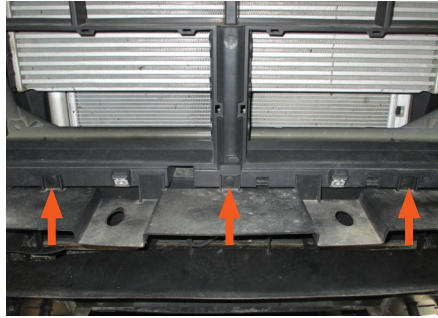

COLORADO ZR2

Step 9

Open the hood and use a T15 Torx bit to remove the six screws holding the top fascia panel in place.

Then, use a T15 Torx bit to remove the five screws along the inside edge of the wheel well liner (not pictured). Repeat on the other side of the vehicle.

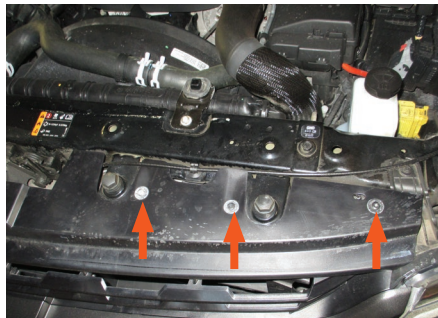

Step 10

Pull the wheel well liner back and use a 7mm socket to remove the three screws where the fascia and fender flare meet.

Repeat on the other side of the vehicle.

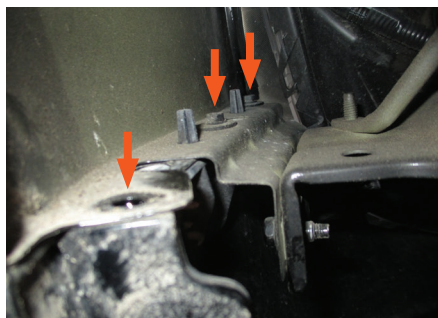

COLORADO ZR2 (CONTINUED)

Step 11

Use a 10mm socket to remove the two screws on the bottom edge of the grille, above the license plate. Then, remove the two screws from inside the center grille opening – one on each side of the vehicle (pictured).



Use a 15mm socket to remove the four screws holding the front underbody panel in place. Once removed, set the panel aside (not pictured).

Use a 10mm socket to remove the screw directly below the tow hook. Then, use a T15 Torx bit to remove the two screws in the wheel well liner panel (not pictured).

Once the panel is removed, use a 7mm socket to remove the screw behind it. Repeat on the other side of the vehicle.

Step 12

Carefully remove the bumper cover, disconnecting the fog light wiring harnesses (if present) before complete removal.

Set the bumper aside to be installed later.



Step 13

Remove the three push pins on top of the air baffle. Then, use a flathead screwdriver to unsnap the outside edges of the baffle.

Once removed, set the baffle aside.



Step 14

Use a 15mm socket to remove the four bolts holding the factory bumper in place.

Remove the bumper and set it aside.

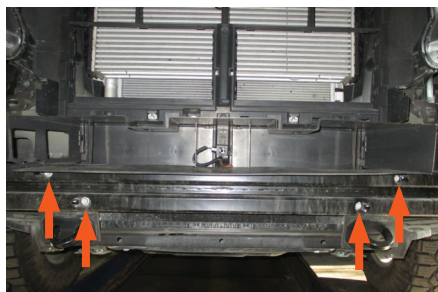

TOW BAR BASE PLATE INSTALLATION

NOTICE

It is your responsibility to watch for oil cooler and air conditioner lines, electrical wires and hoses, and missing parts or attaching points on the frame. If the baseplate is improperly installed and is against a wire or hose, it could cause fluid leaks or electrical shorts some time after the actual baseplate installation.

Step 15

Remove the front temperature sensor and bracket in the center of the vehicle.

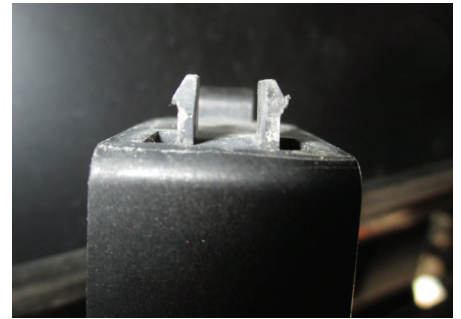
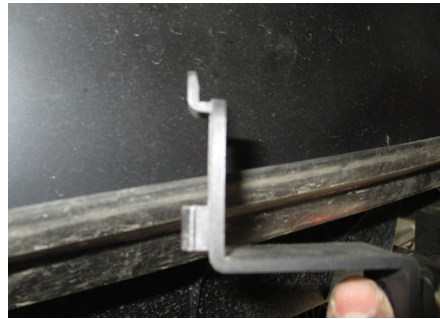
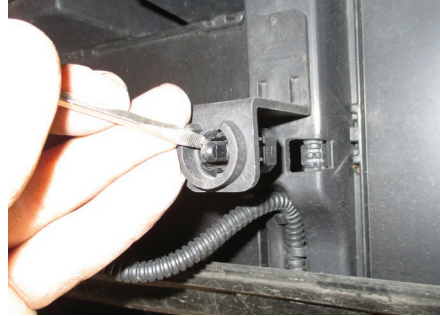

Step 16

Use an 18mm socket to remove the two bolts holding the tow hook in place. Remove the tow hook and set it aside.

Repeat on the other side of the vehicle.

Note: Colorado ZR2 models have foam trim pieces on the tow hooks that need to be removed.



Step 17

Carefully slide the tow bar base plate (#1) onto the frame and rotate into position evenly as it will be snug, lining up the square mounting holes with the factory tow hook holes.

Reinstall the tow hook as shown and secure both the base plate and tow hook with the previously removed factory bolts.

Snug the hardware, but do not fully tighten. Repeat on the other side of the vehicle.

Note: For models without tow hooks, install the spacer plates (#4) between the frame and the base plate (#1). Loosely secure with the supplied 1/2" carriage bolts (#7) and flange nuts (#8).

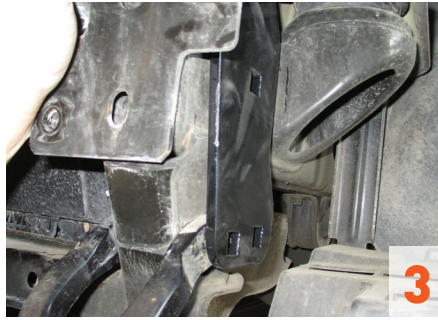

Step 18

Insert a 1/2" carriage bolt (#7) into the base plate (#1) square hole partially into the frame.

Slide a spacer plate (#4) and tube spacer (#3) into the existing hole on the inside edge of the vehicle frame onto the carriage bolt (#7). Slide the carriage bolt in the rest of the way and loosely install 1/2" flange nut (#8).

Repeat on the other side of the vehicle.



Step 19

Lift up on the base plate (#1), making sure it is as high as possible and level.

Torque 1/2" fasteners to 110 lb-ft.

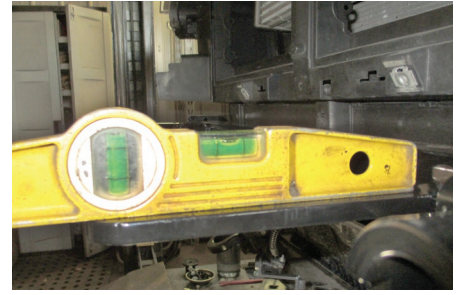

Step 20

Install the permanent safety cables and quick links (#6, #10), looping them around the vehicle frame and linking them to the tow bar base plate (#1). There must be one cable on each side of the vehicle.

Make sure the cables do not pinch or interfere with any hoses, wiring or other components. See 'Installing the Permanent Base Plate Safety Cables' for additional information.



Step 21

Trim the backing off the temperature sensor bracket as shown. Then, use a self-tapping screw or the provided zip tie (#9) to attach the trimmed bracket to the plastic radiator shroud.

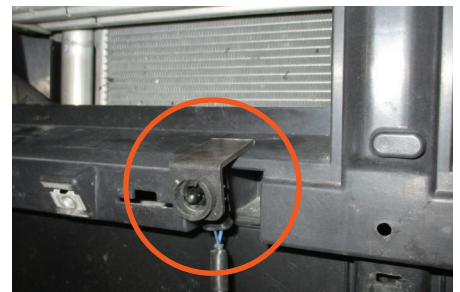
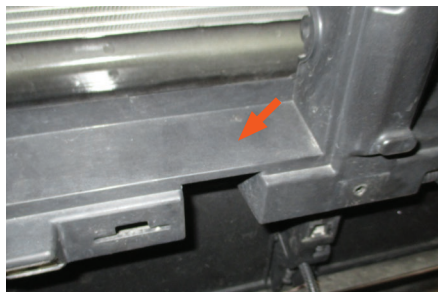

Step 22

Use a metal-cutting tool (reciprocating saw or cutoff wheel) to trim approximately 1-1/2" off of the extension arms on the factory bumper beam.

Reinstall the bumper using the factory hardware.



Step 23

Mark the area on the end of the air baffle 1-1/2" from the bottom edge as shown. Trim off the marked area and repeat on the other side. The support flanges on the inside of the baffle will also need to be removed.

Once modifications are complete, reinstall the air baffle.

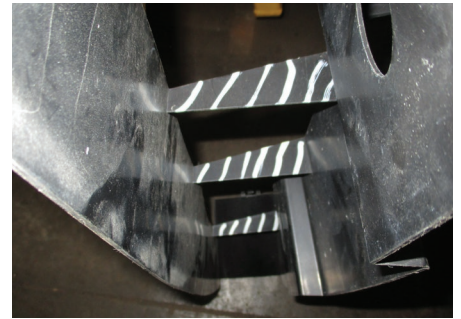

Step 24

Reinstall the bumper cover, any fascia and body panels, fender fasteners and reattach all wiring removed during the installation.

When ready to tow, install the tow bar mounting tabs (#5). When not towing, insert the socket plugs (#11) into the ends of the tow bar base plate (#1).



Final Installed Image



SAFETY CABLE INSTALLATION

Installing the Permanent Base Plate Safety Cables

When dinghy towing a vehicle with a tow bar, base plate safety cables should be used at all times. In the event of a disconnect, the safety cables are designed to help prevent complete vehicle separation. When installing the safety cables, use the illustrations below as a guide.

Installation guidelines

1. The cables must be connected to the base plate and the vehicle frame.
2. Two cables must be installed.
3. Each cable must meet or exceed the gross weight of the towed vehicle.
4. Make sure cables do not pinch or interfere with hoses, wiring or other components.

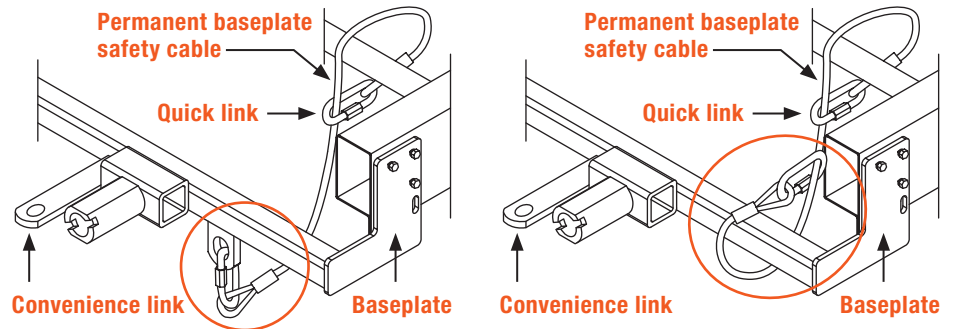

Note: Base plate safety cables are not a replacement for safety chains connecting the tow vehicle to the towed vehicle.

ADDITIONAL INFORMATION

Towing Tips

Check your equipment

Periodically check the condition of all towing equipment. Ensure all fasteners are tight and that all structural components are sound. Do not tow with worn or damaged parts.

Towing vehicle and trailer manufacturer's recommendations

Review the owner's manual for your towing vehicle and trailer for specific recommendations, capacities and requirements.

Product Registration and Warranty

CURT Group stands behind our products with industry-leading warranties.

Provide feedback and help us to improve our products by registering your purchase at: warranty.curtgroup.com/surveys