

INSTALLATION MANUAL

45939

Level of Difficulty

Easy

Weight Capacity

Gross trailer weight (GTW)	20,000 lbs.
Tongue weight (TW)	2,00 lbs.

Parts List

Item	Qty	Description
1	1	Adjustable shank
2	1	Dual ball
3	2	Pin
4	1	Clip

Hitch pin and clip not included

Tools Required

None

Maintenance

Mild automotive detergent may be used to clean the product. Do not use dish detergent, abrasive cleaners, abrasive pads, wire brushes or other similar products that may damage the finish.

⚠ WARNING

Never exceed the vehicle manufacturer's recommended towing capacity. The ratings of the mount system are intended to represent the capability of the product and in no way reflect the ratings or capacity of the towing system it is being used with. The consumer or operator are strongly advised to learn the ratings of the various components of the towing system and never exceed the limits of the lowest rated component being used.

Use of any pin other than that of the mount system manufacturer could be a serious safety hazard and will void the warranty.

Never hook up trailer safety chains to the mount system. Ensure the safety chains operate freely around the mount system and do not become entangled.

Product Photo



NOTICE

Before you begin installation, read all instructions thoroughly.

Product Registration and Warranty

CURT stands behind our products with industry-leading warranties. To get copies of the product warranties, register your purchase or provide feedback, visit: warranty.curtgroup.com/surveys

ASSEMBLY & SETUP

Parts List

Item	Qty	Description
1	1	Adjustable shank
2	1	Dual ball
3	2	Pin
4	1	Clip

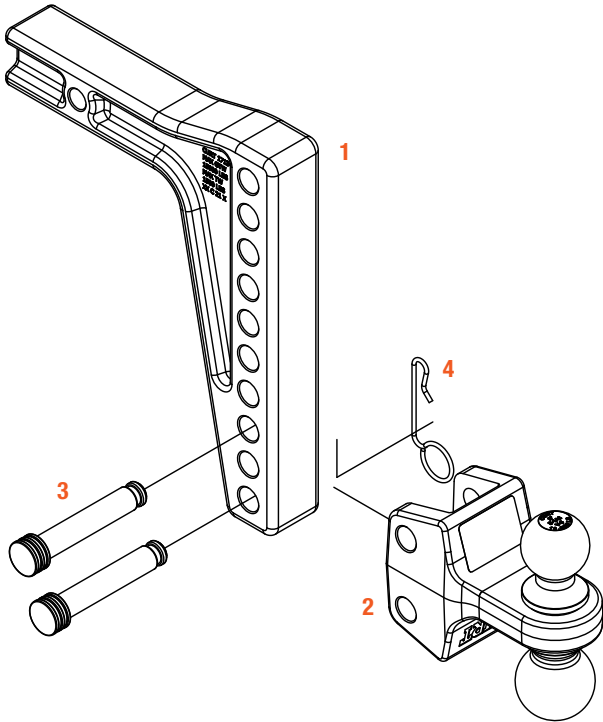

Hitch pin and clip not included

Step 1 - Insert into the Trailer Hitch

Begin by installing the shank (#1) into the trailer hitch receiver and secure it with a hitch pin and clip (sold separately).

Step 2 - Determine Required Ball Height

Determine the proper ball height by leveling the trailer and measuring from the bottom of the trailer tongue to the ground, see below.

Find the hole closest to that measurement on the adjustable shank (#1). The trailer ball platform (#2) will be centered on that hole.

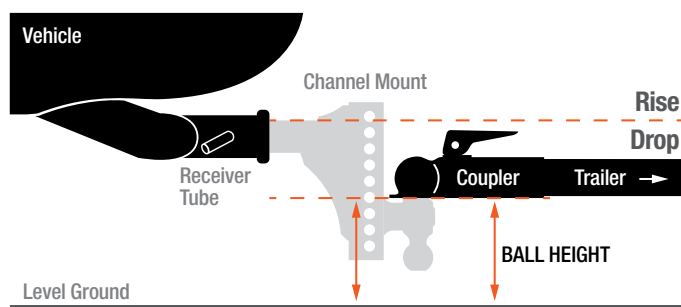

Step 3 - Attach the Tongue

Based on the determined ball height, slide the tongue onto the shank and align with the proper hole locations.

Angle the tongue slightly upwards and press in toward the shank. Insert a pin (#3) into the top tongue hole first. To pin the bottom tongue hole, apply downward force to the tongue, and slide the second pin into place.

Note: The highest mounting position will require the bottom pin to be installed first with the tongue angled downward. Then, apply force upwards to install the second pin.

Secure all pins with the included clip (#4).

⚠ WARNING

The provided pins are specifically engineered for this system. If replacement pins are needed, they must be replaced with original factory mount pins (CURT# 45931).

